

# A-1029/A-1030

## Quick Start Guide

### Lithium Electric Pallet Jack

Rated Load Capacity: 3300/4400lbs

Fork Size: 48x27 inch



Scan the QR Code for more information.

Thank you for choosing our full electric pallet jack.

For safe and correct use, please read this manual carefully and follow all instructions, precautions, and prohibitions. Keep this manual for future reference. Product specifications may change without notice. If there is any difference between this manual and the actual product, the product shall take precedence.

# TABLE OF CONTENTS

## INTRODUCTION

1. Warning
2. Parts Introduction
3. Installation Instruction
4. Inspection & Maintenance
5. Customer Support

# 1. WARNING

## ● Operating Environment

1. Operate this product only on hard, level surfaces.
2. Do not operate if the ambient temperature is above 104°F (40°C) or below 14°F (-10°C).
3. Do not operate in flammable, explosive, or corrosive environments.
4. Do not operate in cold storage or humid environments.

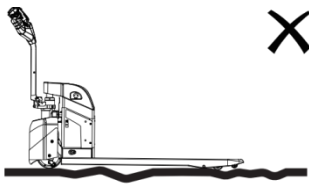
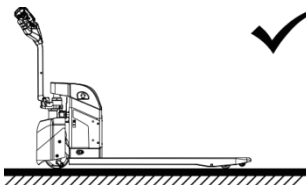

## ● Operational Guidelines

### 1. Personnel Safety

- Do not carry passengers.
- Keep all body parts, especially hands and feet, clear of the forks and moving parts.

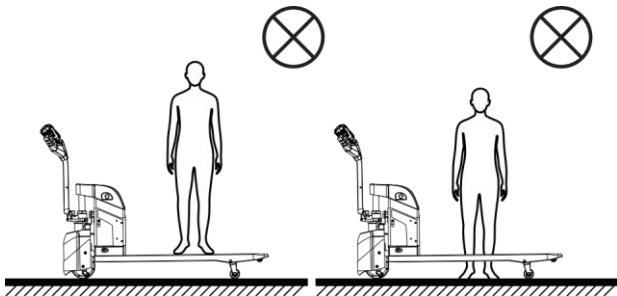

## 2. Load Limits

- Do not exceed the rated load capacity.
- Place loads securely in the center of the forks.
- Do not transport loose or unstable items.

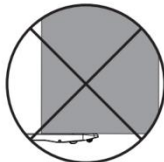
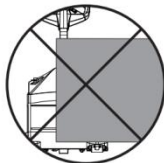
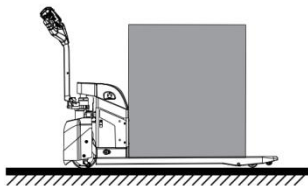

## ● Traveling and Lifting Guidelines

### 1. Starting and Traveling

- Wear safety shoes and ensure familiarity with all controls before starting the product.
- Sound the horn to alert nearby personnel before starting.
- Slowly rotate the forward/reverse rocker on the control handle to control the product's forward or backward speed and direction.

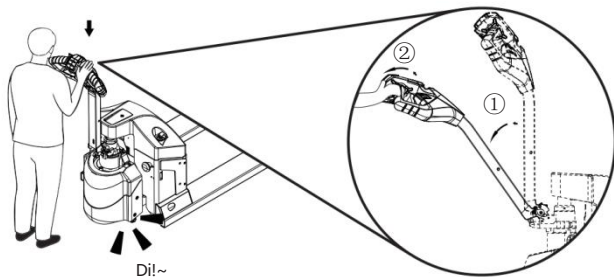

## 2. Braking

- Release the forward/reverse rocker. The product will automatically apply regenerative braking.
- Move the control handle to the vertical or horizontal position. The product will automatically engage electromagnetic braking.
- Press the emergency stop switch. The product will stop immediately.

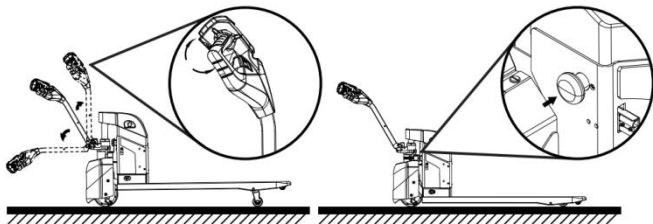

## 3. Lifting and Lowering

- Press the raise button on the control handle to lift the forks.
- Press the lower button on the control handle to lower the forks smoothly.

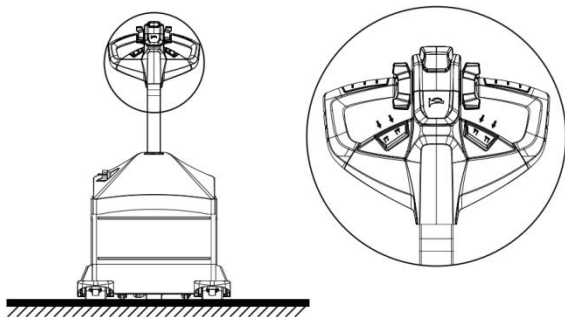

#### 4. Ramp Operation

- When ascending with a load, keep the forks facing uphill.
- When descending, operate the product in reverse, keep the forks facing uphill, and control speed carefully.

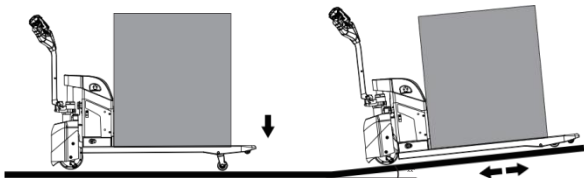

#### 5. Charging

- Lower the forks and turn off the power.
- Charge the product in a well-ventilated area using the designated charger.
- The product is equipped with two lead-acid batteries and can be charged as needed.
- If the product is unused for more than one month, charge the battery monthly to maintain its performance.

#### Note:

- **Charger Types** This product comes with one of two charger configurations (depending on the model)
  - ① Built-in Charger: Integrated into the chassis.
  - ② External Charger: Included as a separate accessory.

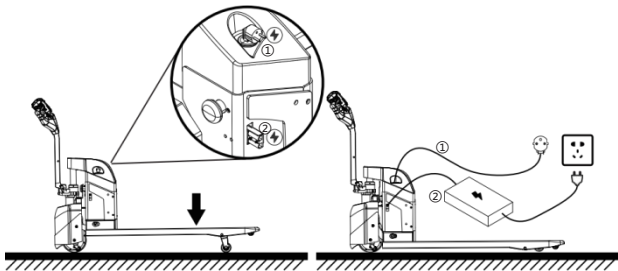

## 2. Parts Introduction

Emergency Reversing Button

Forward/Reverse Rockers

Lift Button

Horn Button

Lower Button

Guide Wheel

Control handle Tiller

Load Wheel

Hydraulic Pump Station

Frame and Forks

Balancing wheel

Fault LED

Battery Indicator

Key Switch

Drive Wheel (Drive Unit)

Emergency Stop Switch

### 3. Installation Instruction

- The product is mostly pre-assembled at the factory.  
Before use, only the control handle needs to be installed.

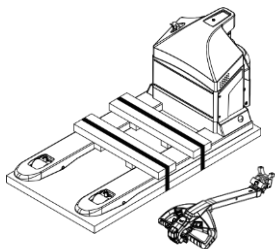

- ① Carefully unpack and check accessories (Charger, Manual, Handle).

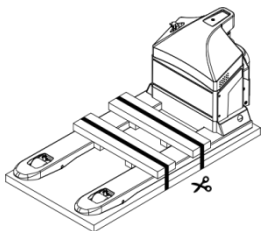

- ② Remove all shipping straps and the protective wood/foam from the handle.

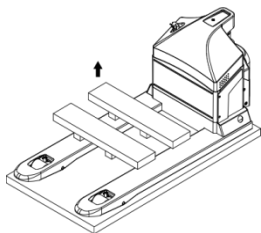

- ③ Remove all shipping straps and the protective wood/foam from the handle.

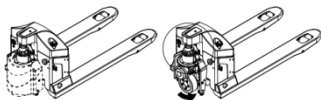
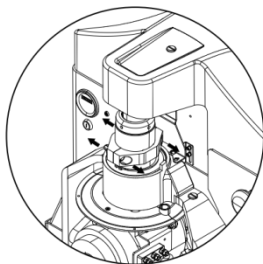

- ④ Align the handle with the base markings and the wire harness. Remove the clamp from the mounting base (Note: Half of the removed clamp is not needed for re-installation).

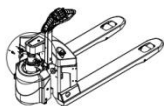
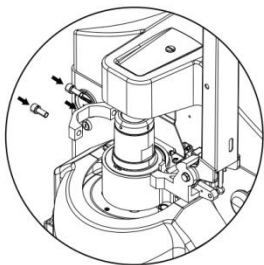

- ⑤ Secure the handle tightly using the Clamp and Hex Screws.

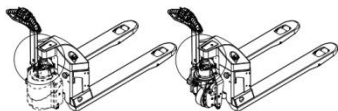
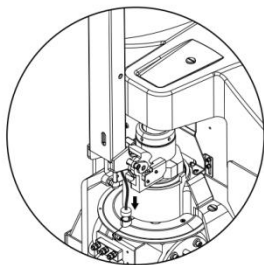

- ⑥ Connect the handle's electrical plug to the base connector.

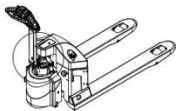
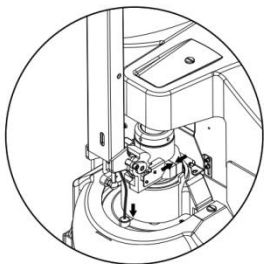

- ⑦ Ensure the connection is secure.

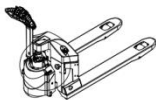
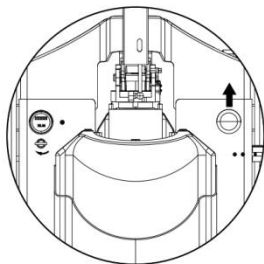

- ⑧ Pull the Emergency Stop and turn on the Key.

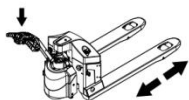
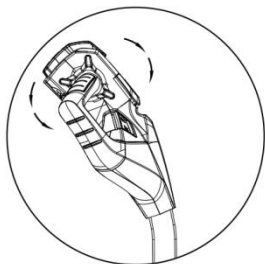

- ⑨ Lower the handle to the drive position and test all functions (Throttle, Lift, Lower, Horn, Turtle Speed).

Lower Button

Lift Button

Horn Button

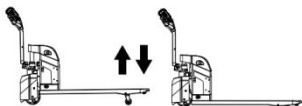

## 4. Inspection & Maintenance

Conducting a thorough inspection of the product can help prevent malfunctions and ensure it achieves its expected service life. Maintenance hours are based on 8 hours of operation per day, 200 hours per month. For safe operation, the product should be inspected and maintained according to the maintenance schedule.

### ● 200-Hour Inspection and Maintenance

No.	Component	Inspection or Service
1	Overall Condition	Check for visible damage or oil leaks (hydraulic oil, gear oil).
2	Fastener	Check all bolts, especially on wheels and handle, for looseness
3	Electrical System	Check the battery charge level and ensure the horn and emergency stop switch function properly.
4	Brake (Interlock Switch)	Check that the brake works effectively when the handle is in vertical and horizontal positions.
5	Wheel	Inspect drive wheels and load wheels for serious wear or entanglement with debris.
6	Horn	Check sound function.
7	Hydraulic Oil	Check oil level. Replace after the first 500 hours, then every 1,000 hours thereafter.
8	Control Handle	Check for binding or looseness in steering.
9	Frame & Fastener	Inspect for cracks; check if all fasteners are secure.
10	Connecting Rod Wheel Carrier	Inspect for cracks, bends, or deformation.
11	Hydraulic Pump & Oil Pipe	Check for leakage.
12	Power Plug	Ensure proper function and check for damage.
13	Emergency Stop Switch	Ensure proper function and check for damage.
14	Key Switch	Ensure proper function and check for damage.
15	Brake	Clean dirt and dust from brake pads; check wear condition.
16	Drive Wheel	Check for wear; replace if function is impaired.
17	Fork Wheel, Guide Wheel & Bearing	Check for wear; replace if function is impaired.
18	Lubrication	Apply grease to all bearings and pivot points.

### ● Maintenance Intervals for Consumables and Components

Component	Inspection or Service	Interval (hours)
Fork Wheel Bearing	Replace	1,200
Fork Wheel	Replace	1,200
Seal	Replace	1,200
Gearbox	Change lubricant	1,000
Hydraulic Oil	Replace	1,000
Drive Wheel Tire	Replace	2,000
Drive Motor	Inspect brushes and bearings	1,000
Oil Pump Motor	Inspect brushes and bearings	1,000

## 5. Customer Support

- Warranty Period

1. **New Product (Complete Unit):**

1-year warranty from the date of receipt.

2. **Spare Parts:**

3-month warranty from the date of receipt.

3. **Battery:**

6-month warranty from the date of receipt.

4. **Used Product (Complete Unit):**

3-month warranty from the date of receipt.

- Warranty Coverage

Complete product and its accessories.

- Non-Warranty Items

1. Wearable parts, such as wheels under normal use and fuses.

2. Damage caused by improper or incorrect operation.

1. **Apollo Sales-after: [service@apolloliftus.com](mailto:service@apolloliftus.com)**

Apollo Customer Service: 224-353-6408

2. **XILIN Sales-after: [support@xilin.com](mailto:support@xilin.com)**

XILIN Customer Service Phone: 224-353-6341

3. **Tory Carrier Sales-after: [service@torycarrier.com](mailto:service@torycarrier.com)**

Tory Carrier Customer Service Phone: 224-353-6781

4. **Aequanta Sales-after: [service@aequanta.com](mailto:service@aequanta.com)**

Aequanta Customer Service Phone: 224-353-6408 (暂时同Apollo)

Working Hours: 9:00 AM to 5:30 PM CDT ( 夏季 ) /CST ( 冬季 )